

SRM Series Wired Square Clock (V4.3)

Features:

- Available in 9" (22.8cm), and 12" (30.4 cm) dial sizes
- Offered in a stylish ABS case
- Multiple power options
 - Offered in 110VAC, 230VAC and 24VAC/VDC models
- Provided with mounting hardware for easy installation
- Hour, minute, and second hands
- Quick correction for time change (max. 5 minutes when used with digital communication protocol)
- Microprocessor based movement
- Side molded, polycarbonate crystal

Highlights:

- Uses Sapling RS485 time data protocol
- Correctly interprets time data protocols even if the **signal** wire polarity is switched.
- Built-in self-diagnostic mode:
 - Communication Protocol Verification
 - Time since the last synchronization signal was received
 - Hand position error detection
- Custom Color Cases available (minimum quantity 25)
- Designed and Produced by Sapling Inc. in Pennsylvania, United States of America



Specification sheets may change without prior notice

SRM Series Wired Square Clock (V4.3)

Specifications:

Case Material:

ABS

Case Color:

Standard black or white back case, metallic gray front rim (custom colors available)

Dial Face:

12 or 24 (military) hour standard
Specialty dials available

Dial Material:

Durable polystyrene

Crystal Material:

Shatter-proof, side-molded, transparent polycarbonate

Voltage Input:

7 - 28 VDC/VAC 50/60 Hz (24V model)
85 - 130 VAC 50/60 Hz (110V model)
180 - 260 VAC 50/60 Hz (230V model)

Average Current Consumption:

35 mA @ 24VAC
25 mA @ 110VAC
15 mA @ 230VAC

Hand tolerance:

Minute hand: +/- 1/4 minute
Second hand: +/- 1/2 second

Temperature range:

Operating: 32°F - 113°F (0°C - 45°C)
Shelf: 5°F - 167°F (-15°C - 75°C)

Compliance:

UL, cUL listed, CE Compliances: EMC, LVD



Ordering Information:

SRM Series Wired Square Clock: SRM-4XS-XXS-X-XX

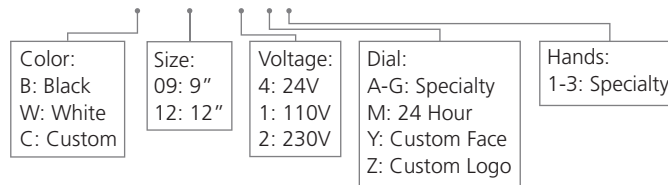

Double Mount Pole: SAB-1XD-XXS-0

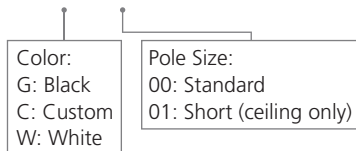

Note: Purchasing double mounted square analog clocks will require two clocks using the clock part number and one double mount pole using the part number above.

Examples:

SRM-4WS-09S-4: Sapling Analog, Wired SRM, 9" Square, 24V, Surface Wall Mount, White Case with Metallic Gray Rim, Supports: RS485 Protocol

SRM-4BS-12S-1: Sapling Analog, Wired SRM, 12" Square, 110 VAC, Surface Wall Mount, Mineral Black Case with Metallic Gray Rim, Supports: RS485 Protocols

SRM Series Wired Square Clock (V4.3)

Sapling Square Analog Clock Dimensions

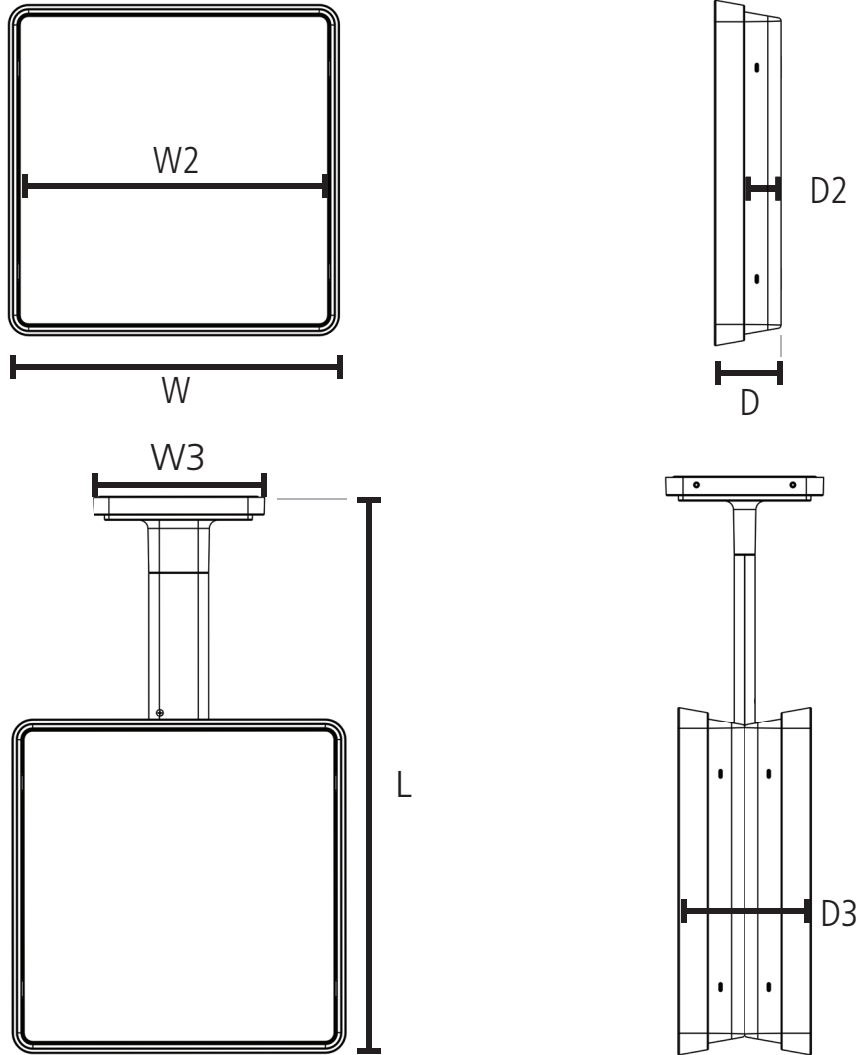

	9" Square	12" Square
Clock Size:	W = 9.79" (24.9cm) W2 = 8.97" (22.8cm) D = 2.44" (6.2cm) D2 = 1.34" (3.4cm)	W = 12.76" (32.4cm) W2 = 11.94" (30.3cm) D = 2.44" (6.2cm) D2 = 1.34" (3.4cm)
Shipping Weight:	3.0lbs (1.81kg)	4.0lbs (1.81kg)
Double/Dual Mount Dimensions:	W3 = 6.56" (16.7cm) D3 = 4.93" (12.5cm)	W3 = 6.56" (16.7cm) D3 = 4.93" (12.5cm)
Adjustable Pole Height for standard pole*:	L3 = 18.32" (46.5cm)	L = 21.12" (53.6cm) L = 19.35" (49.1cm)
Shortened Pole Height:	L = 12.38" (31.4cm)	L = 15.50" (39.3cm)

***Standard** pole refers to part number SAB-1GD-00S-0

****Shortened** pole (ceiling mount only) refers to part number SAB-1GD-01S-0

SRM Series Wired Square Clock (V4.3)

Hand & Dial Options

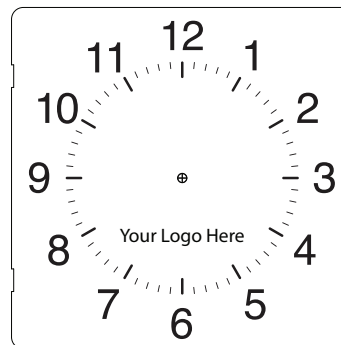
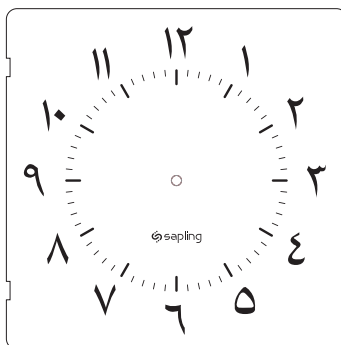
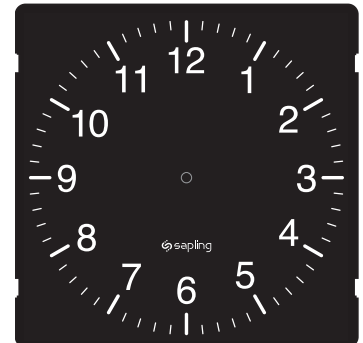
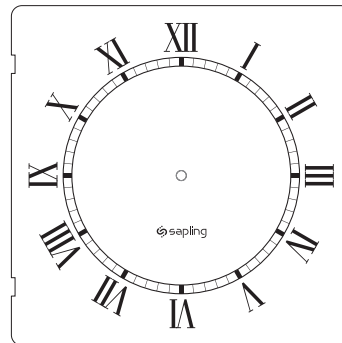
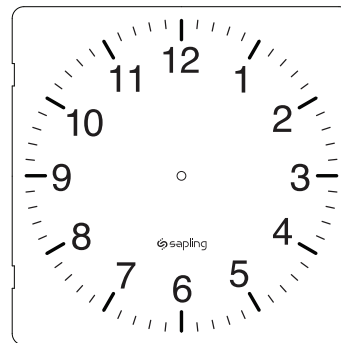
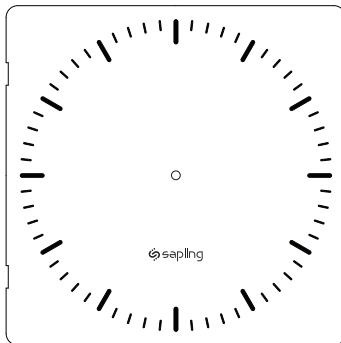
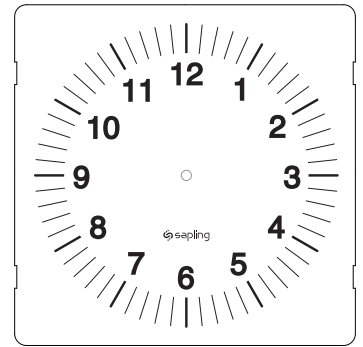
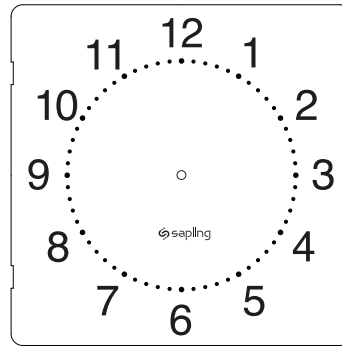
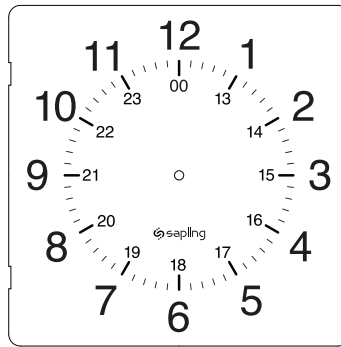
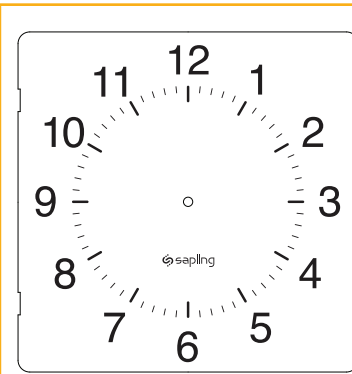
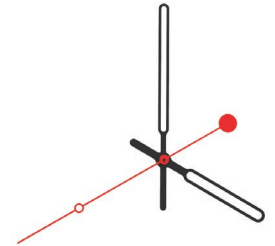
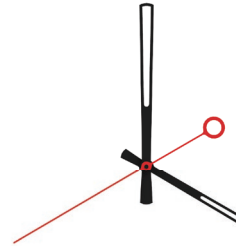
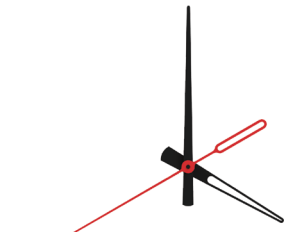

Specialty Hands 1-3 & Specialty Dials A-Z are offered at an additional cost.

For more information please contact your Sapling Representative.