

SAT Series Wireless TalkBack 900MHz Round Clock (V4.2)

Features:

- Available in 9", 12", and 16" dial sizes
- Offered in a SlimLine ABS case
 - Optional Cherry Wood finish or Brushed Aluminum finish
- Multiple power options
 - Offered in 24/110VAC, 230VAC, and battery-powered models
- Provided with mounting hardware for easy installation
- Hour, minute, and second hands
- Quick correction for time change (max. 5 minutes)
- Microprocessor based movement
- Internal Antenna
- Side molded, polycarbonate crystal
- FCC Compliant per FCC part 15 Section 15,247

Highlights:

- Reports to the Master Clock using Sapling's TalkBack protocol:
 - Mechanical Status
 - Signal Strength
 - Battery voltage (when applicable)
- Each clock acts as a repeater for the time data signal
- Energy efficient
- 900 MHz frequency hopping technology to ensure signal reliability
 - No FCC License Required
- Receives and repeats the time data
 - Once every minute if locally powered
 - Once every two hours if battery powered
- Built-in self-diagnostic mode:
 - Signal reception strength
 - Clock movement testing
 - Battery level if battery-powered
- Custom Color Cases available (minimum order quantity 25)
- Designed and Produced by Sapling Inc. in Pennsylvania, United States of America

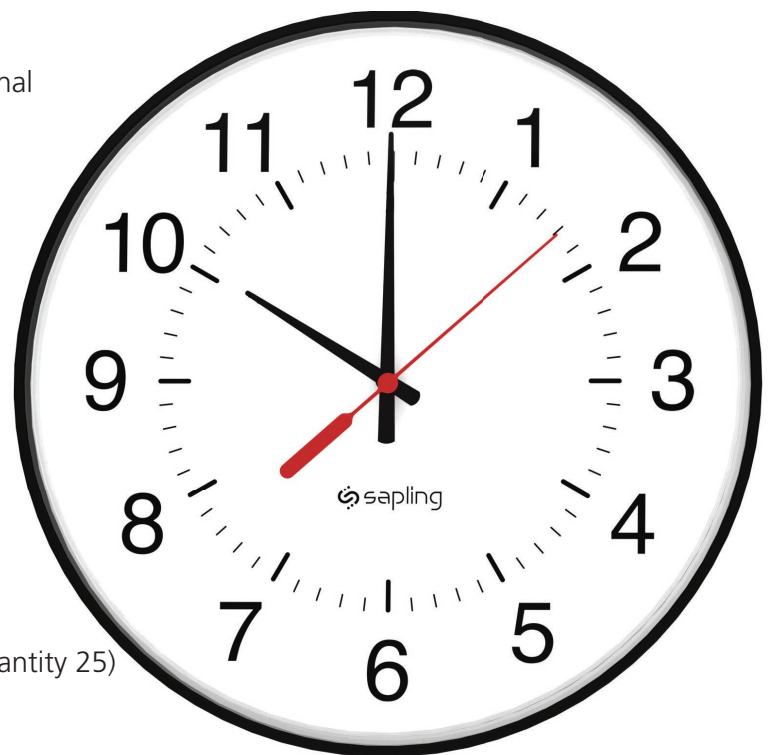

Specification sheets may change without prior notice

SAT Series Wireless TalkBack 900MHz Round Clock (V4.2)

Specifications:

Case Material:

Acrylonitrile Butadiene Styrene (ABS).
Cherry wood finish or brushed aluminum finish for the SlimLine ABS case is also available.

Case Color:

Standard black finish (custom colors available)

Dial Face:

12 or 24 (military) hour standard
Specialty dials available

Dial Material:

Durable polystyrene

Crystal Material:

Shatter-proof, side-molded, transparent polycarbonate

Voltage Input:

Two 1.5V "D" Cell Alkaline Batteries (Battery model)
11 - 28 VDC/VAC 50/60 Hz (24V model)
85 - 130 VAC 50/60 Hz (110V model)
180 - 260 VAC 50/60 Hz (230V model)

Average Current Consumption:

Battery - 5 years
35 mA @ 24VDC/VAC
25 mA @ 110VAC
15 mA @ 230VAC

Hand tolerance:

Minute hand: +/- 1/4 minute

Second hand: +/- 1/2 second

Temperature range:

Operating: 32°F - 113°F (0°C - 45°C)

Shelf: 5°F - 167°F (-15°C - 75°C)

Operating frequencies:

915-928 MHz while frequency-hopping

Transceiver parameters:

Transmitter power output: 8 dbm

Receiver sensitivity: -103 dbm

Compliance:

UL and cUL listed, FCC part 15 Section 15.247

Ordering Information:

SAT Series Wireless Round Clock: SAT-XXS-XXR-X-XX

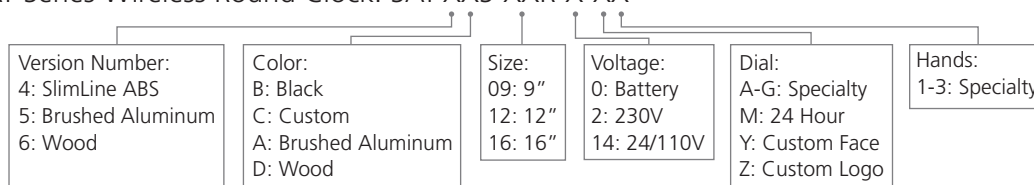

Double Mount Hosuing: SAX-4XD-XXR-0

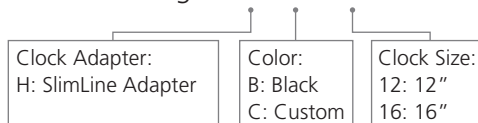

Note: Purchasing double mounted round analog clocks will require two clocks using the clock part number and one double mount housing using the part number above.

Examples:

SAT-5AS-09R-0 Sapling Analog, TalkBack Wireless SlimLine, 900 MHz, 9" Round, Battery-Operated, Surface Wall Mount, Brushed Aluminum Case
SAT-6DS-16R-14 Sapling Analog, TalkBack Wireless SlimLine, 900 MHz, 16" Round, 24/110 VAC, Surface Wall Mount, Solid Cherry Wood Frame



SAT Series Wireless TalkBack 900MHz Round Clock (V4.2)

Sapling Round Analog Clock Dimensions

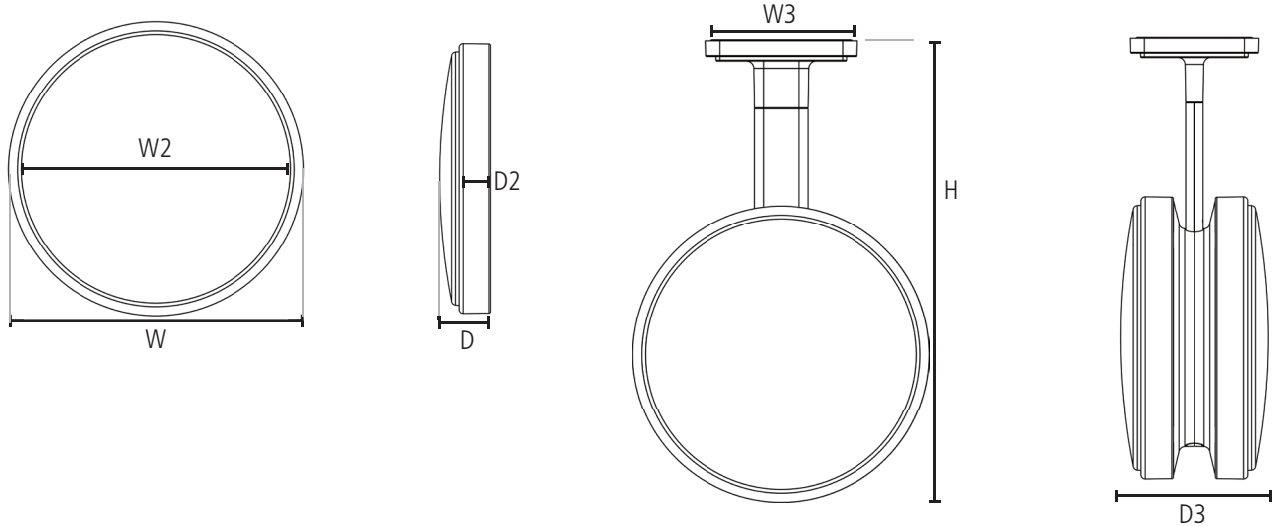

SLIMLINE ABS

Clock Size:	9" SlimLine	12" SlimLine	16" SlimLine
W	9.8" (24.8cm)	12.9" (32.7cm)	16.7" (42.3cm)
W2	9.5" (24.2cm)	12.6" (32.0cm)	16.3" (41.5cm)
D	2.4" (6.2cm)	2.4" (6.2cm)	2.5" (6.4cm)
D2	1.7" (4.2cm)	1.7" (4.3cm)	1.7" (4.4cm)
Shipping Weight:	2 lbs (0.9 kg)	2 lbs (0.9 kg)	4 lbs (1.8 kg)
Double/Dual Mount Dimensions:	Not Applicable	W3 = 6.6" (16.7cm) D3 = 6.4" (16.2cm)	W3 = 6.6" (16.7cm) D3 = 6.4" (16.3cm)
Adjustable Pole Height:	Not Applicable	H = 19.7" (50.2cm) = 18.1" (46.1cm) = 16.5" (41.9cm)	H = 21.7" (55.3cm) = 20.1" (51.2cm) = 18.5" (47.0cm)

ALUMINUM

WOODEN

Clock Size:	9" Aluminum	12" Aluminum	16" Aluminum	9" Wood	12" Wood	16" Wood
W	10.7" (27.1cm)	13.8" (35.0cm)	17.8" (45.1cm)	11.6" (29.5cm)	13.3" (33.8cm)	19.6" (49.9cm)
W2	9.5" (24.2cm)	12.6" (32.0cm)	16.3" (41.5cm)	9.5" (24.2cm)	12.6" (32.0cm)	16.5" (41.5cm)
D	2.4" (6.2cm)	2.4" (6.2cm)	2.4" (6.4cm)	D* = 2.4" (6.2cm)	D* = 2.4" (6.2cm)	D* = 2.4" (6.4cm)
D2	1.7" (4.2cm)	1.7" (4.4cm)	1.7" (4.4cm)	D2* = 2.7" (6.8cm)	D2* = 2.7" (6.8cm)	D2* = 2.7" (6.8cm)
Shipping Weight:	2 lbs (0.9kg)	3 lbs (1.4 kg)	4 lbs (1.8 kg)	3 lbs (kg)	4 lbs (1.8 kg)	6 lbs (2.7 kg)
Double/Dual Mount Dimensions:	Not Applicable	W3 = 6.6" (16.7cm) D3 = 6.4" (16.2cm)	W3 = 6.6" (16.7cm) D3 = 6.4" (16.3cm)	Not Applicable	Not Applicable	Not Applicable
Adjustable Pole Height:	Not Applicable	H = 20.2" (51.5cm) = 18.6" (47.3cm) = 17.0" (43.2cm)	H = 22.3" (56.6cm) = 20.6" (52.4cm) = 19.0" (48.2cm)	Not Applicable	Not Applicable	Not Applicable

*NOTE: For wood clocks, the rim (D2) protrudes further from the wall than the crystal (D).

SAT Series Wireless TalkBack 900MHz Round Clock (V4.2)

Hand & Dial Options



Standard Hands



Specialty Hands 1

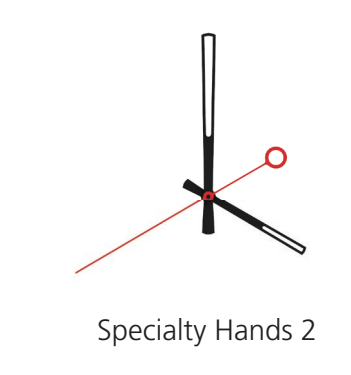

Specialty Hands 2

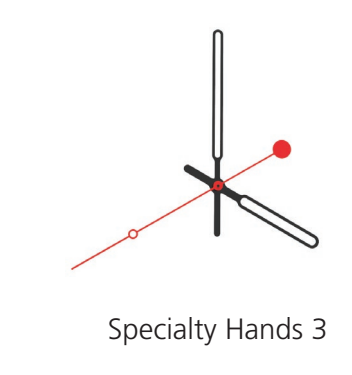

Specialty Hands 3

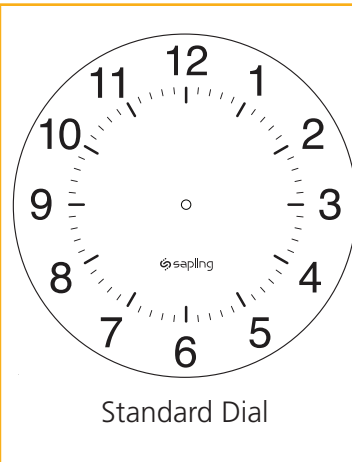

Standard Dial

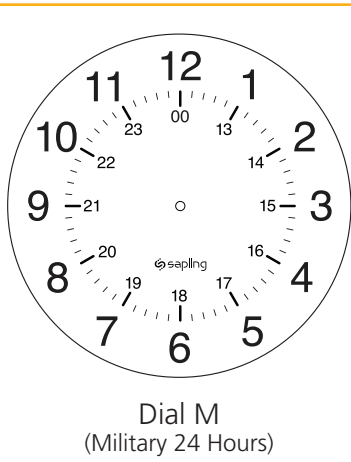

Dial M
(Military 24 Hours)

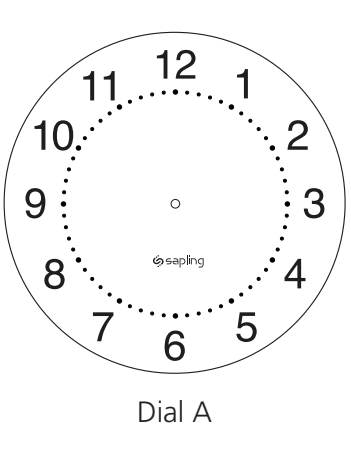

Dial A

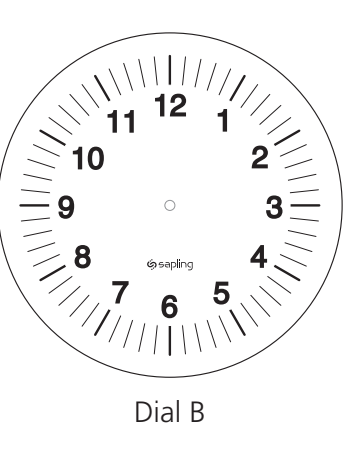

Dial B

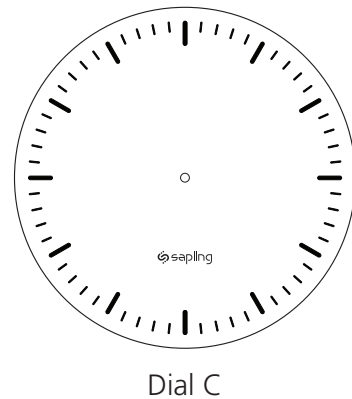

Dial C

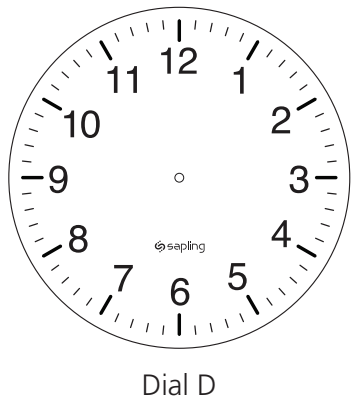

Dial D

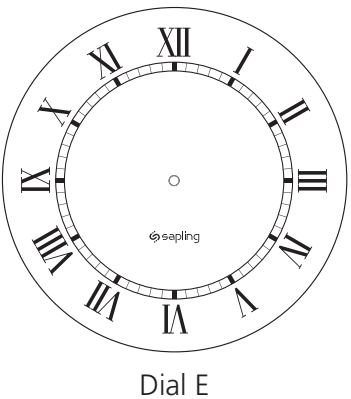

Dial E



Dial F

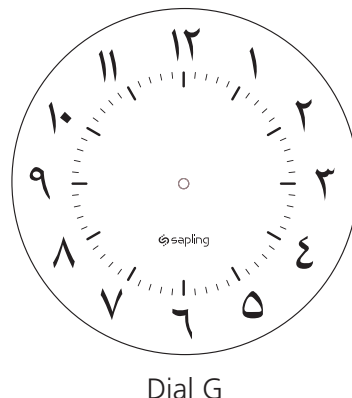

Dial G

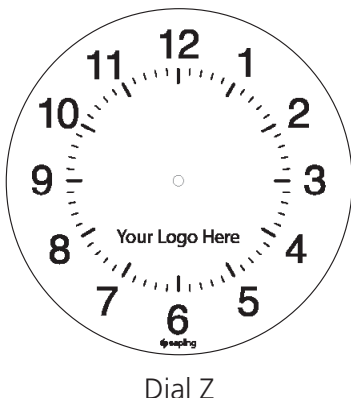

Dial Z

Specialty Hands 1-3 & Specialty Dials A-Z are offered at an additional cost.

For more information please contact your Sapling Representative.

SAT Series Wireless TalkBack 900MHz Round Clock (V4.2)

Clock Case Options

