

SAP Series IP Square Clock (V5.6)

Features:

- Available in 9" (22.8cm), and 12" (30.4 cm) dial sizes
- Offered in a stylish ABS case
- Power over Ethernet (802.3af standard)
 - Power and data are provided through one standard network cable (CAT 5, CAT 5e, or CAT 6)
- Provided with mounting hardware for easy installation
- Hour, minute, and second hands
- Quick correction for time change (max. 5 minutes)
- Microprocessor based movement
- Side molded, polycarbonate crystal

Highlights:

- Built-in web interface - each clock has a built in web interface allowing the user to set, control, and monitor the IP clock
 - Built-in web interface settings include: Network settings, NTP server selection, UTC/GMT offset selection, automatic Daylight Saving Time adjustments, and much more!
- Receives time data from one of ten pre-programmed third party NTP servers (user changeable) for added reliability and redundancy. Alternatively, it can be set to receive the time data from an in-house NTP Server or from any Sapling Master Clock model.
- Built-in self-diagnostics and email alerts for:
 - NTP Synchronization Timeouts
 - Power resets
 - Hand position errors and corrections
- Interfaces with Sapling's IP Clock Monitor software which will allow the user to view, monitor, and send various commands to all IP clocks in the system
- Custom Color Cases available (minimum quantity 25)
- Designed and Produced by Sapling Inc. in Pennsylvania, United States of America



SAP Series IP Square Clock (V5.6)

Specifications:

Case Material:

ABS

Case Color:

Standard black or white back case, metallic gray front rim (custom colors available)

Dial Face:

12 or 24 (military) hour standard

Specialty dials available

Dial Material:

Durable polystyrene

Crystal Material:

Shatter-proof, side-molded, transparent polycarbonate

Data Protocols:

NTP, SNTP, Sapling Proprietary

Routing Protocols:

IPv4

Voltage Input:

48 VDC (PoE model)

Average Current Consumption:

70mA @ 48 VDC (PoE Class 1)

Hand tolerance:

Minute hand: +/- 1/4 minute

Second hand: +/- 1/2 second

Temperature range:

Operating: 32°F - 113°F (0°C - 45°C)

Shelf: 5°F - 167°F (-15°C - 75°C)

Compliance:

UL, cUL listed



Ordering Information:

SAP Series IP Square Clock: SAP-4XS-XXS-0-XX

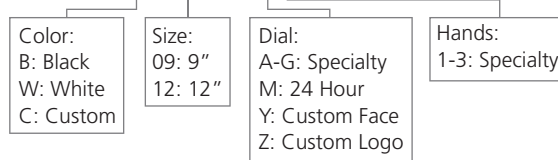

Double Mount Pole: SAB-XXD-XXS-0

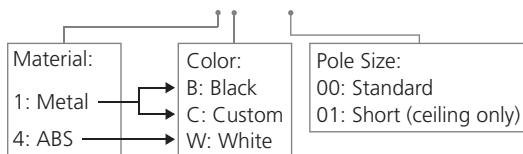

*Standard length black poles will always be metal (SAB-1BD-005-0)
 *Short length black poles will always be ABS (SAB-4BD-015-0)
 *Standard length white poles will always be ABS (SAB-4WD-005-0)

Note: Purchasing double mounted square analog clocks will require two clocks using the clock part number and one double mount pole using the part number above.

Examples:

SAP-4WS-09S-0: Sapling Analog, IP, 9" Square, Surface Wall Mount, White Case with Metallic Gray Rim

SAP-4BS-12S-0: Sapling Analog, IP, 12" Square, Surface Wall Mount, Mineral Black Case with Metallic Gray Rim

Specification sheets may change without prior notice

SAP Series IP Square Clock (V5.6)

Sapling Square Analog Clock Dimensions

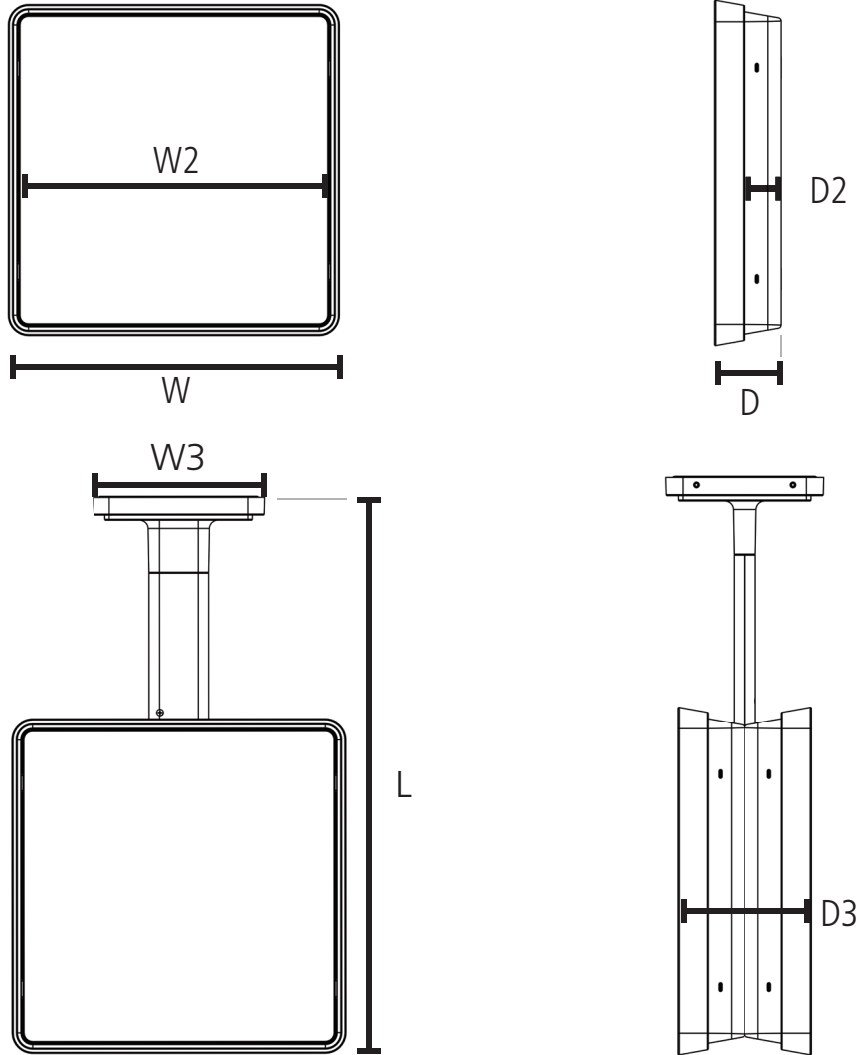

	9" Square	12" Square
Clock Size:	W = 9.79" (24.9cm) W2 = 8.97" (22.8cm) D = 2.44" (6.2cm) D2 = 1.34" (3.4cm)	W = 12.76" (32.4cm) W2 = 11.94" (30.3cm) D = 2.44" (6.2cm) D2 = 1.34" (3.4cm)
Shipping Weight:	3.0lbs (1.81kg)	4.0lbs (1.81kg)
Double/Dual Mount Dimensions:	W3 = 6.56" (16.7cm) D3 = 4.93" (12.5cm)	W3 = 6.56" (16.7cm) D3 = 4.93" (12.5cm)
Adjustable Pole Height for standard pole*:	L3 = 18.32" (46.5cm)	L = 21.12" (53.6cm) L = 19.35" (49.1cm)
Shortened Pole Height:	L = 12.38" (31.4cm)	L = 15.50" (39.3cm)

***Standard** pole refers to part number SAB-1GD-00S-0

****Shortened** pole (ceiling mount only) refers to part number SAB-1GD-01S-0

SAP Series IP Square Clock (V5.6)

Hand & Dial Options



Standard Hands

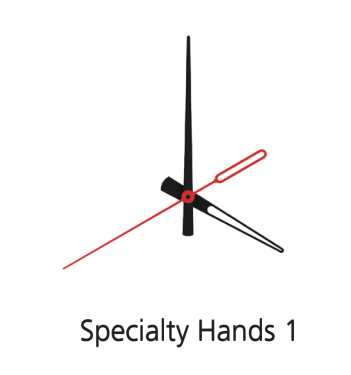

Specialty Hands 1

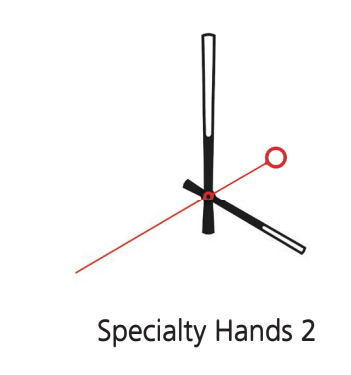

Specialty Hands 2

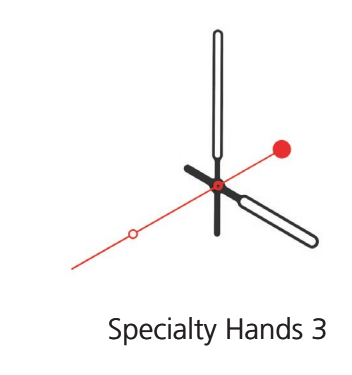

Specialty Hands 3

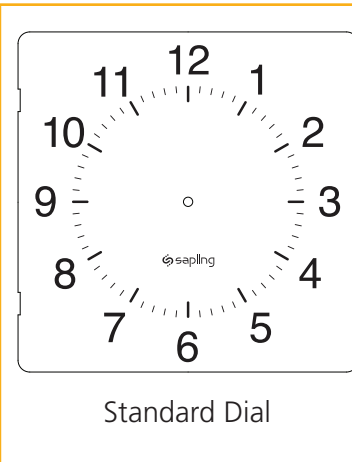

Standard Dial

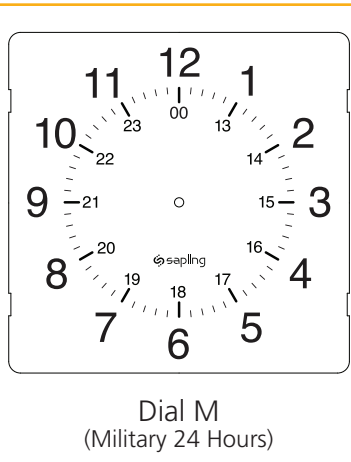

Dial M
(Military 24 Hours)

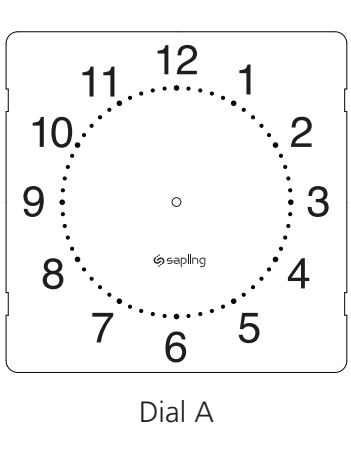

Dial A

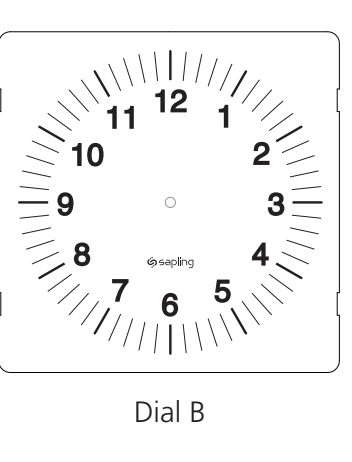

Dial B

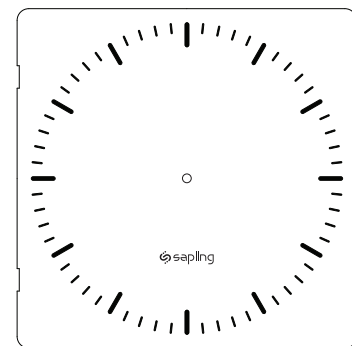

Dial C

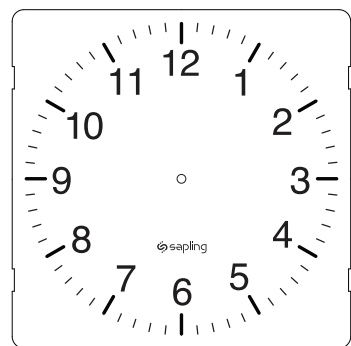

Dial D

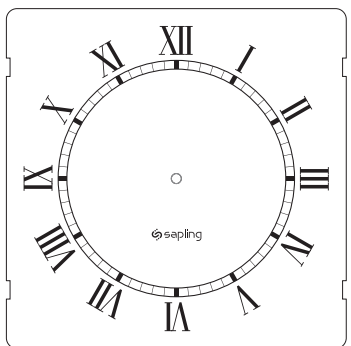

Dial E

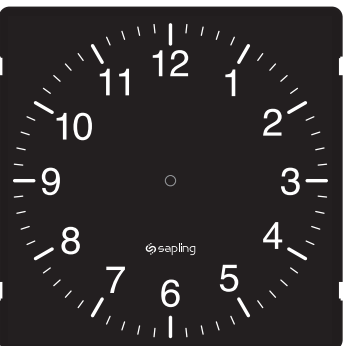

Dial F

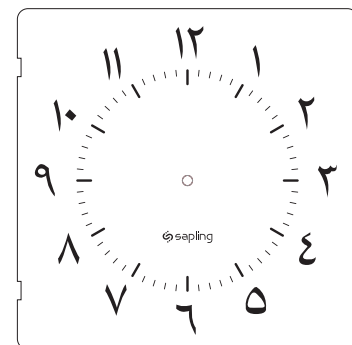

Dial G

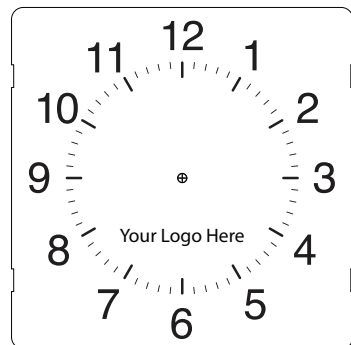

Dial Z

Specialty Hands 1-3 & Specialty Dials A-Z are offered at an additional cost.

For more information please contact your Sapling Representative.