

## SALG Series Wireless 2.4GHz Round Clock (V5.7)

### Features:

- Available in 9", 12", and 16" dial sizes
- Offered in a SlimLine ABS case
  - Optional Cherry Wood finish or Brushed Aluminum finish
- Multiple power options
  - Offered in 24/110VAC, 230VAC, and battery-powered models
- Provided with mounting hardware for easy installation
- Hour, minute, and second hands
- Quick correction for time change (max. 5 minutes)
- Microprocessor based movement
- Internal Antenna
- Side molded, polycarbonate crystal
- FCC Compliant per FCC part 15 Section 15,247

### Highlights:

- Each clock acts as a repeater for the time data signal
- Energy efficient
- 2.4 GHz frequency hopping technology to ensure signal reliability
  - No FCC License Required
- Receives and repeats the time data
  - Once every minute if locally powered
  - Once every two hours in standard mode, or once every four hours in economy mode if battery powered
- Built-in self-diagnostic mode:
  - Signal reception strength
  - Clock movement testing
  - Battery level if battery-powered
- Custom Color Cases available (minimum order quantity 25)
- Designed and Produced by Sapling Inc. in Pennsylvania, United States of America

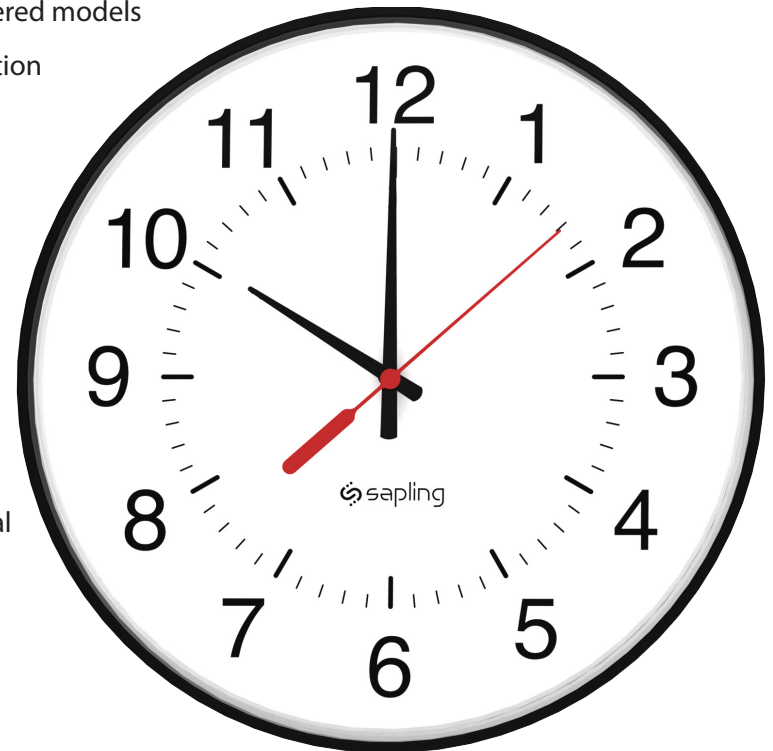

## SALG Series Wireless 2.4GHz Round Clock (V5.7)

### Specifications:

#### Case Material:

Acrylonitrile Butadiene Styrene (ABS).  
Cherry wood finish or brushed aluminum finish for the SlimLine ABS case is also available.

#### Case Color:

Standard black finish (custom colors available)

#### Dial Face:

12 or 24 (military) hour standard  
Specialty dials available

#### Dial Material:

Durable polystyrene

#### Crystal Material:

Shatter-proof, side-molded, transparent polycarbonate

#### Voltage Input:

Two 1.5V "D" Cell Alkaline Batteries (Battery model)  
11 - 28 VDC/VAC 50/60 Hz (24V model)  
85 - 130 VAC 50/60 Hz (110V model)  
180 - 260 VAC 50/60 Hz (230V model)

#### Average Current Consumption:

Battery - 5 years (standard mode)  
8 years (economy mode)  
35 mA @ 24VDC/VAC  
25 mA @ 110VAC  
15 mA @ 230VAC

#### Hand tolerance:

Minute hand: +/- 1/4 minute  
Second hand: +/- 1/2 second

#### Temperature range:

Operating: 32°F - 113°F (0°C - 45°C)  
Shelf: 5°F - 167°F (-15°C - 75°C)

#### Operating frequencies:

2.4 GHz while frequency-hopping

#### Transceiver parameters:

Transmitter power output: 8 dbm  
Receiver sensitivity: -103 dbm

#### Compliance:

UL and cUL listed, FCC part 15 Section 15.247

### Ordering Information:

SALG Series Wireless Round Clock: SALG-XXS-XXR-X-XX

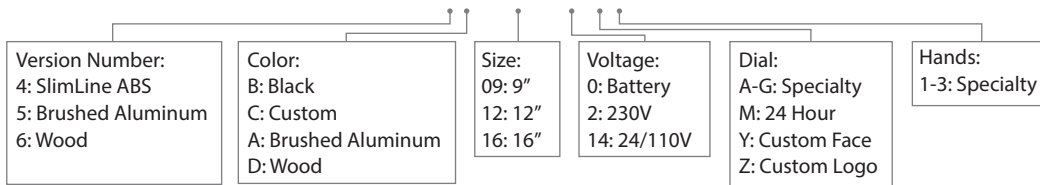

Double Mount Housing: SAX-4XD-XXR-0

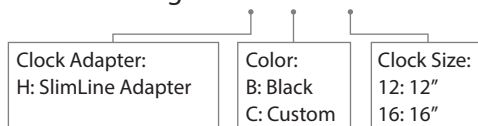

Note: Purchasing double mounted round analog clocks will require two clocks using the clock part number and one double mount housing using the part number above.

#### Examples:

SALG-5AS-09R-0 Sapling Analog, Wireless SlimLine, 2.4 GHz, 9" Round, Battery-Operated, Surface Wall Mount, Brushed Aluminum Case  
SALG-6DS-16R-14 Sapling Analog, Wireless SlimLine, 2.4 GHz, 16" Round, 24/110 VAC, Surface Wall Mount, Solid Cherry Wood Frame

# SALG Series Wireless 2.4 GHz Round Clock (V5.7)

## Sapling Round Analog Clock Dimensions

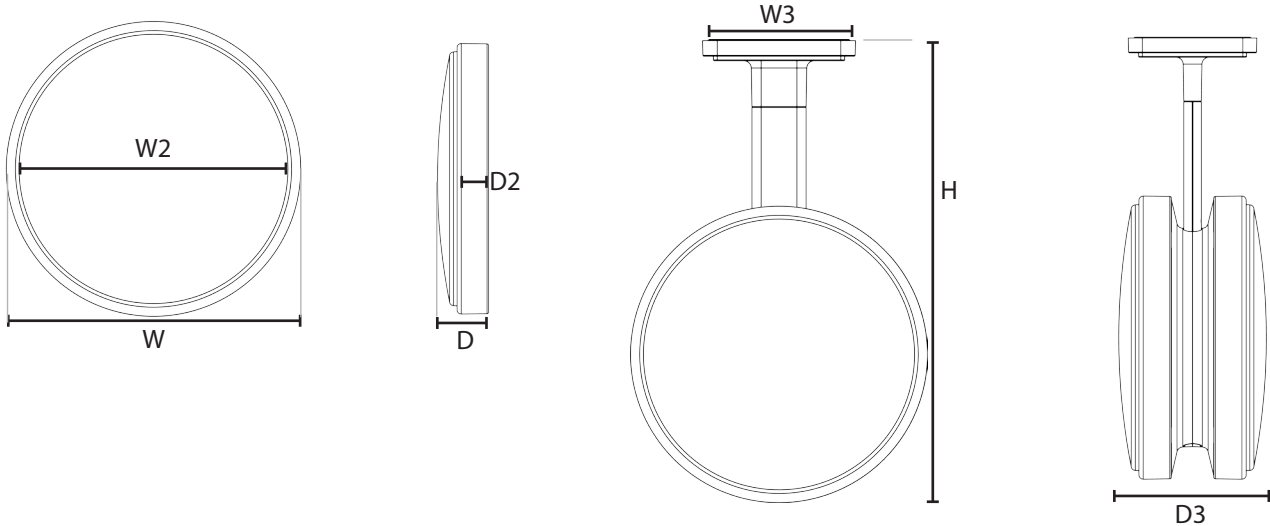

### SLIMLINE ABS

Clock Size:	9" SlimLine	12" SlimLine	16" SlimLine
W	9.8" (24.8cm)	12.9" (32.7cm)	16.7" (42.3cm)
W2	9.5" (24.2cm)	12.6" (32.0cm)	16.3" (41.5cm)
D	2.4" (6.2cm)	2.4" (6.2cm)	2.5" (6.4cm)
D2	1.7" (4.2cm)	1.7" (4.3cm)	1.7" (4.4cm)
Shipping Weight:	2 lbs (0.9 kg)	2 lbs (0.9 kg)	4 lbs (1.8 kg)
Double/Dual Mount Dimensions:	Not Applicable	W3 = 6.6" (16.7cm) D3 = 6.4" (16.2cm)	W3 = 6.6" (16.7cm) D3 = 6.4" (16.3cm)
Adjustable Pole Height:	Not Applicable	H = 19.7" (50.2cm) = 18.1" (46.1cm) = 16.5" (41.9cm)	H = 21.7" (55.3cm) = 20.1" (51.2cm) = 18.5" (47.0cm)

### ALUMINUM

### WOODEN

Clock Size:	9" Aluminum	12" Aluminum	16" Aluminum	9" Wood	12" Wood	16" Wood
W	10.7" (27.1cm)	13.8" (35.0cm)	17.8" (45.1cm)	11.6" (29.5cm)	13.3" (33.8cm)	19.6" (49.9cm)
W2	9.5" (24.2cm)	12.6" (32.0cm)	16.3" (41.5cm)	9.5" (24.2cm)	12.6" (32.0cm)	16.5" (41.5cm)
D	2.4" (6.2cm)	2.4" (6.2cm)	2.4" (6.4cm)	D* = 2.4" (6.2cm)	D* = 2.4" (6.2cm)	D* = 2.4" (6.4cm)
D2	1.7" (4.2cm)	1.7" (4.4cm)	1.7" (4.4cm)	D2* = 2.7" (6.8cm)	D2* = 2.7" (6.8cm)	D2* = 2.7" (6.8cm)
Shipping Weight:	2 lbs (0.9kg)	3 lbs (1.4 kg)	4 lbs (1.8 kg)	3 lbs (kg)	4 lbs (1.8 kg)	6 lbs (2.7 kg)
Double/Dual Mount Dimensions:	Not Applicable	W3 = 6.6" (16.7cm) D3 = 6.4" (16.2cm)	W3 = 6.6" (16.7cm) D3 = 6.4" (16.3cm)	Not Applicable	Not Applicable	Not Applicable
Adjustable Pole Height:	Not Applicable	H = 20.2" (51.5cm) = 18.6" (47.3cm) = 17.0" (43.2cm)	H = 22.3" (56.6cm) = 20.6" (52.4cm) = 19.0" (48.2cm)	Not Applicable	Not Applicable	Not Applicable

\*NOTE: For wood clocks, the rim (D2) protrudes further from the wall than the crystal (D).

SALG Series Wireless 2.4GHz Round Clock (V5.7)

Hand & Dial Options

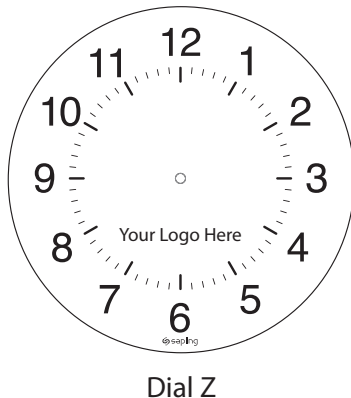
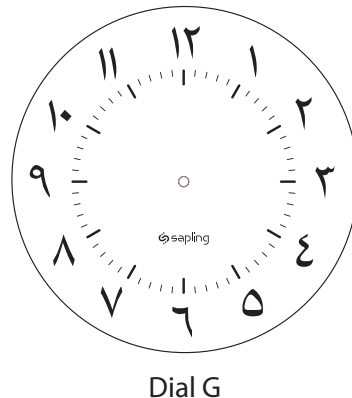
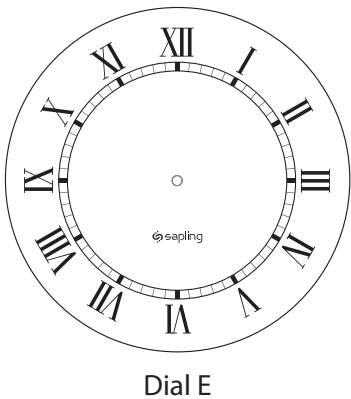
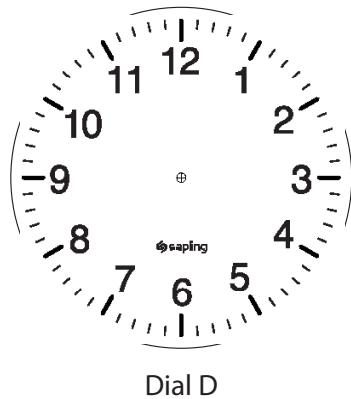
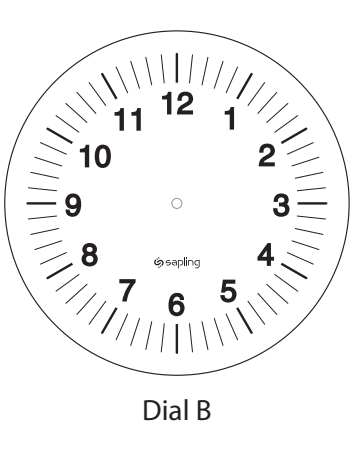
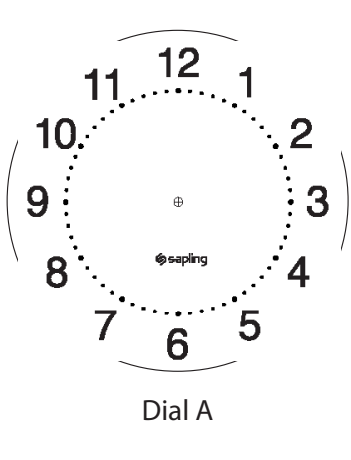
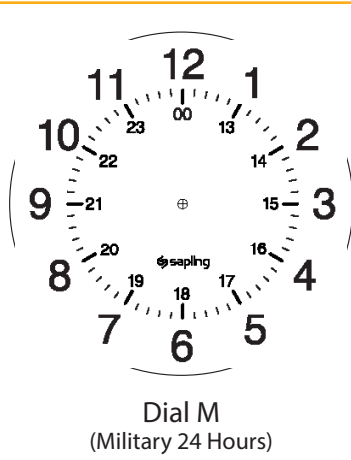
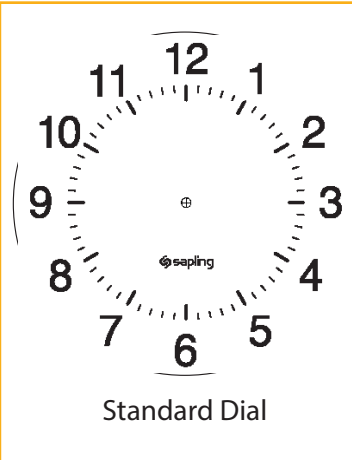
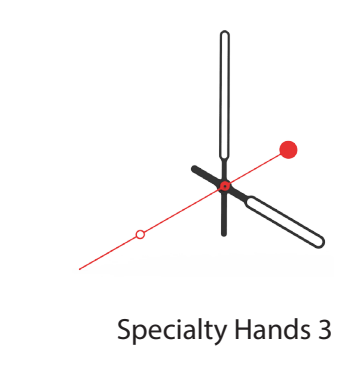
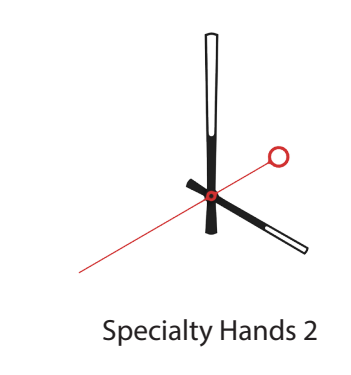
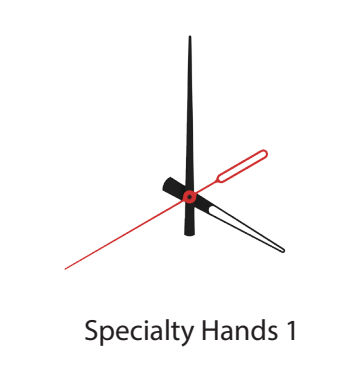
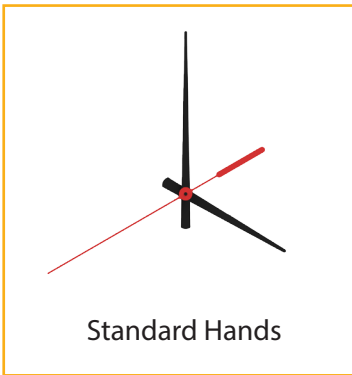

Specialty Hands 1-3 & Specialty Dials A-Z are offered at an additional cost.

For more information please contact your Sapling Representative.

SALG Series Wireless 2.4GHz Round Clock (V5.7)

Clock Case Options



Standard SlimLine  
ABS Case



Brushed Aluminum Finish



Solid Wood Case Cherry Finish

