

SAL Series Wireless 900MHz Square Clock (V5.9)

Features:

- Available in 9" (22.8cm), and 12" (30.4 cm) dial sizes
- Offered in a stylish ABS case
- Multiple power options
 - Offered in 24/110VAC, 230VAC, and battery-powered models
- Provided with mounting hardware for easy installation
- Hour, minute, and second hands
- Quick correction for time change (max. 5 minutes)
- Microprocessor based movement
- Internal Antenna
- Side molded, polycarbonate crystal
- FCC Compliant per FCC part 15 Section 15,247

Highlights:

- Each clock acts as a repeater for the time data signal
- Energy efficient
- 900 MHz frequency hopping technology to ensure signal reliability
 - No FCC License Required
- Receives and repeats the time data
 - Once every minute if locally powered
 - Once every two hours in standard mode, or once every four hours in economy mode if battery powered
- Built-in self-diagnostic mode:
 - Signal reception strength
 - Clock movement testing
 - Battery level if battery-powered
- Custom Color Cases available (minimum order quantity 25)
- Designed and Produced by Sapling Inc. in Pennsylvania, United States of America



SAL Series Wireless 900MHz Square Clock (V5.9)

Specifications:

Case Material:

Acrylonitrile Butadiene Styrene (ABS).

Case Color:

Standard black or white back case, metallic gray front rim (custom colors available)

Dial Face:

12 or 24 (military) hour standard

Specialty dials available

Dial Material:

Durable polystyrene

Crystal Material:

Shatter-proof, side-molded, transparent polycarbonate

Voltage Input:

Two 1.5V "D" Cell Alkaline Batteries (Battery model)

11 - 28 VAC 50/60 Hz (24V model)

85 - 130 VAC 50/60 Hz (110V model)

180 - 260 VAC 50/60 Hz (230V model)

Average Current Consumption:

Battery - 5 years (standard mode)

8 years (economy mode)

35 mA @ 24VAC

25 mA @ 110VAC

15 mA @ 230VAC

Hand tolerance:

Minute hand: +/- 1/4 minute

Second hand: +/- 1/2 second

Temperature range:

Operating: 32°F - 113°F (0°C - 45°C)

Shelf: 5°F - 167°F (-15°C - 75°C)

Operating frequencies:

915-928 MHz while frequency-hopping

Transceiver parameters:

Transmitter power output: 8 dbm

Receiver sensitivity: -103 dbm

Compliance:

UL and cUL listed, FCC part 15 Section 15.247

Ordering Information:

SAL Series Wireless Square Clock: SAL-4XS-XXS-X-XX

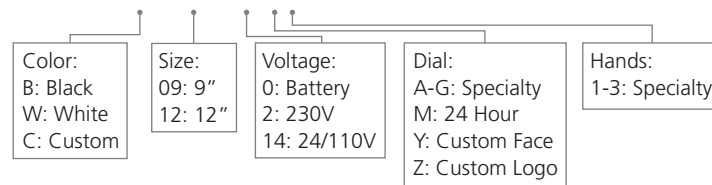

Double Mount Pole: SAB-1XD-XXS-0

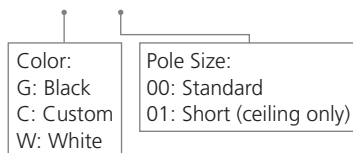

Note: Purchasing double mounted round analog clocks will require two clocks using the clock part number and one double mount housing using the part number above.

Examples:

SAL-4WS-09S-0: Sapling Analog, Wireless 900 MHz, 9" Square, Battery-Operated, Surface Wall Mount, White Case with Metallic Gray Rim

SAL-4BS-12S-14: Sapling Analog, Wireless 900 MHz, 12" Square, 24V/110VAC, Surface Wall Mount, Mineral Black Case with Metallic Gray Rim

Specification sheets may change without prior notice



SAL Series Wireless 900MHz Square Clock (V5.9)

Sapling Square Analog Clock Dimensions

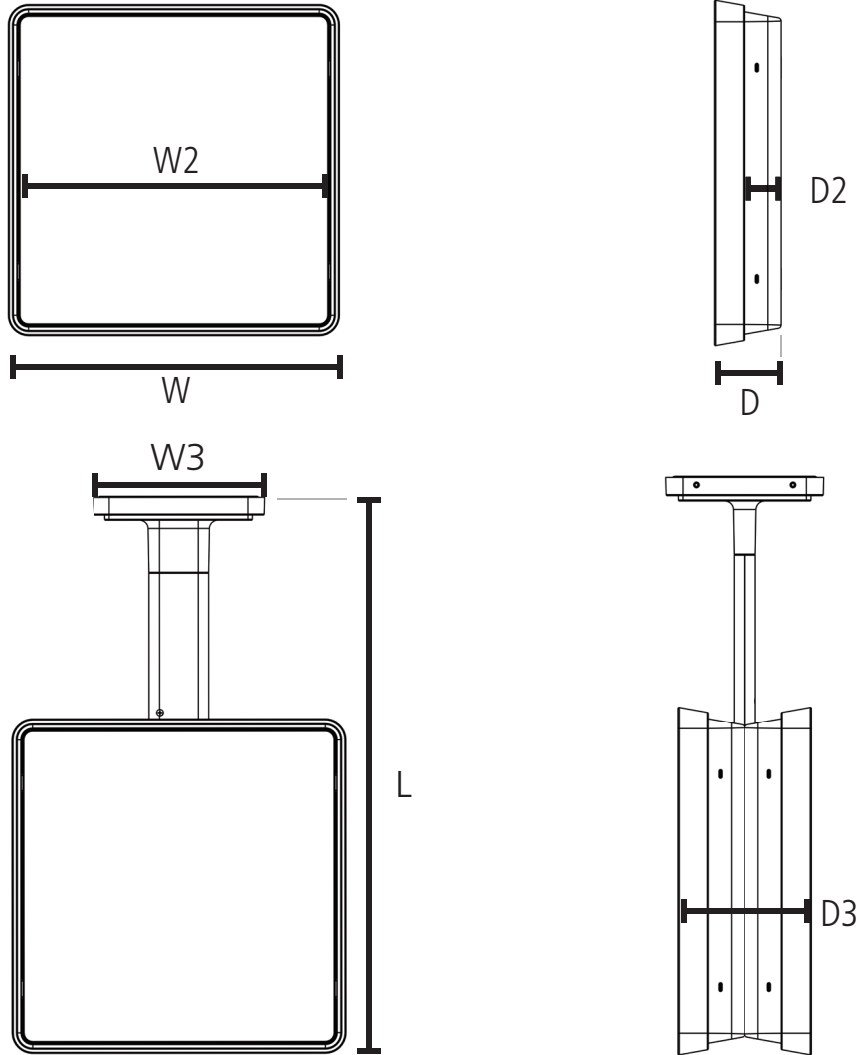

	9" Square	12" Square
Clock Size:	W = 9.79" (24.9cm) W2 = 8.97" (22.8cm) D = 2.44" (6.2cm) D2 = 1.34" (3.4cm)	W = 12.76" (32.4cm) W2 = 11.94" (30.3cm) D = 2.44" (6.2cm) D2 = 1.34" (3.4cm)
Shipping Weight:	3.0lbs (1.81kg)	4.0lbs (1.81kg)
Double/Dual Mount Dimensions:	W3 = 6.56" (16.7cm) D3 = 4.93" (12.5cm)	W3 = 6.56" (16.7cm) D3 = 4.93" (12.5cm)
Adjustable Pole Height for standard pole*:	L3 = 18.32" (46.5cm)	L = 21.12" (53.6cm) L = 19.35" (49.1cm)
Shortened Pole Height:	L = 12.38" (31.4cm)	L = 15.50" (39.3cm)

*Standard pole refers to part number SAB-1GD-00S-0

**Shortened pole (ceiling mount only) refers to part number SAB-1GD-01S-0

SAL Series Wireless 900MHz Square Clock (V5.9)

Hand & Dial Options

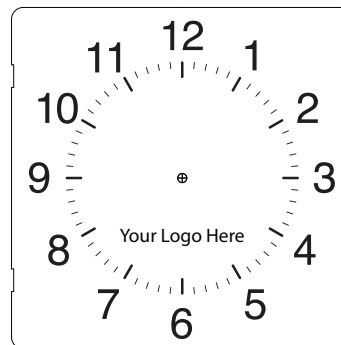
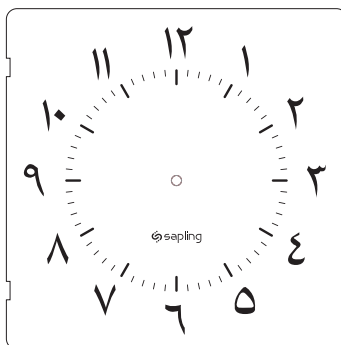
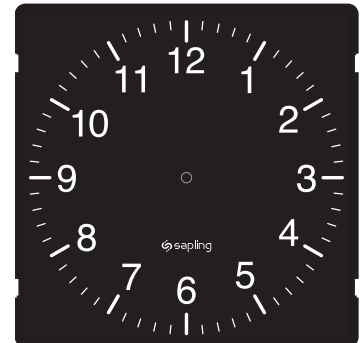
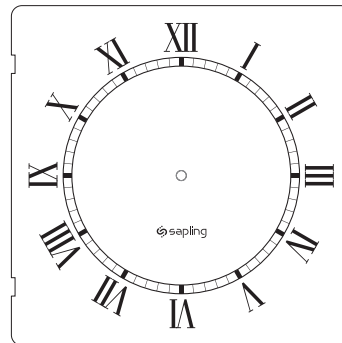
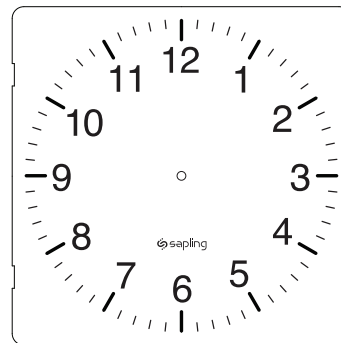
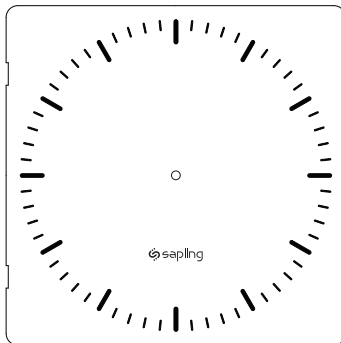
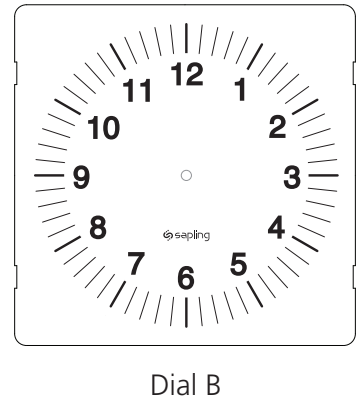
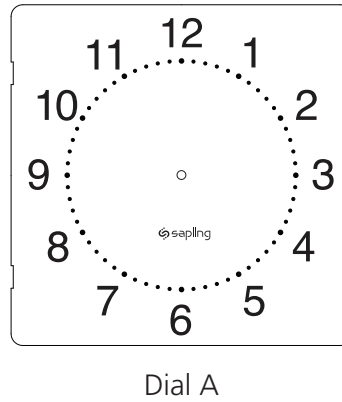
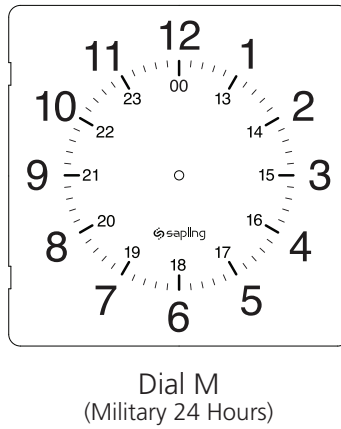
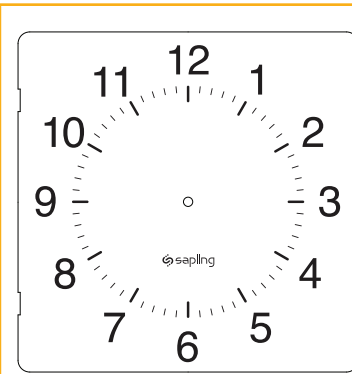
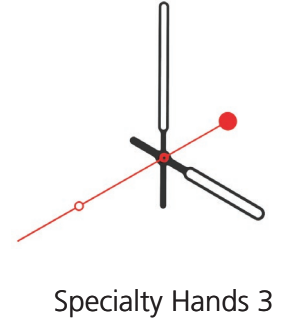
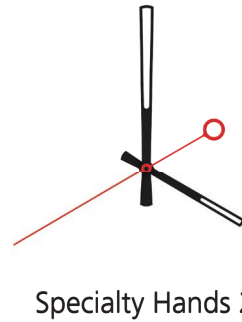
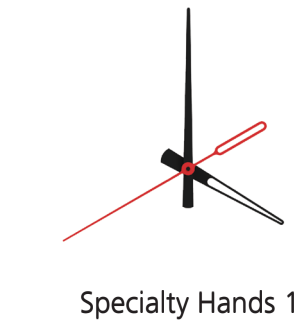

Specialty Hands 1-3 & Specialty Dials A-Z are offered at an additional cost.

For more information please contact your Sapling Representative.