

## SAI Series Quartz Independent Square Clock (V5.8)

### Features:

- Available in 9" (22.8 cm), and 12" (30.4 cm) dial sizes
- Offered in a stylish ABS case
- Energy efficient: Uses one AA battery
- Provided with mounting hardware for easy installation
- Hour, minute, and second hands
- Side molded, polycarbonate crystal

### Highlights:

- Custom Color Cases available (minimum order quantity 25)
- Designed and Produced by Sapling Inc. in Pennsylvania, United States of America



Specification sheets may change without prior notice

## SAI Series Quartz Independent Square Clock (V5.8)

### Specifications:

#### Case Material:

Acrylonitrile Butadiene Styrene (ABS).

#### Case Color:

Standard black or white back case, metallic gray front rim (custom colors available)

#### Dial Face:

12 or 24 (military) hour standard

Specialty dials available

#### Dial Material:

Durable polystyrene

#### Crystal Material:

Shatter-proof, side-molded, transparent polycarbonate

#### Voltage Input:

One 1.5V "AA" Cell Battery

#### Battery Depletion Rate:

One year

#### Quartz Oscillator Frequency:

32.768 KHz at 77°F (25°C)

#### Accuracy:

+/- 0.8 seconds per day at 77°F (25°C)

#### Temperature range:

Operating: -4°F - 140°F (-20°C - 60°C)

Shelf: -4°F - 158°F (-20°C - 70°C)

### Ordering Information:

SAI Series Quartz Square Independent Clock: SAI-4XS-XXS-0

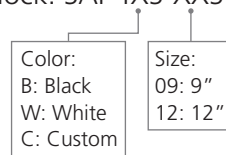

Double Mount Pole: SAB-XXD-XXS-0

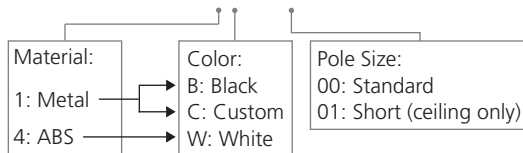

\*Standard length black poles will always be metal (SAB-1BD-00S-0)

\*Short length black poles will always be ABS (SAB-4BD-01S-0)

\*Standard length white poles will always be ABS (SAB-4WD-00S-0)

**Note:** Purchasing double mounted round analog clocks will require two clocks using the clock part number and one double mount housing using the part number above.

#### Examples:

SAI-4WS-09S-0: Sapling Analog, Quartz SlimLine, 9" Square, Battery-Operated, Surface Wall Mount, White Case with Metallic Gray Rim

SAI-4BS-12S-0: Sapling Analog, Quartz SlimLine, 12" Square, Battery-Operated, Surface Wall Mount, Mineral Black Case with Metallic Gray Rim

# SAI Series Quartz Independent Square Clock (V5.8)

## Sapling Square Analog Clock Dimensions

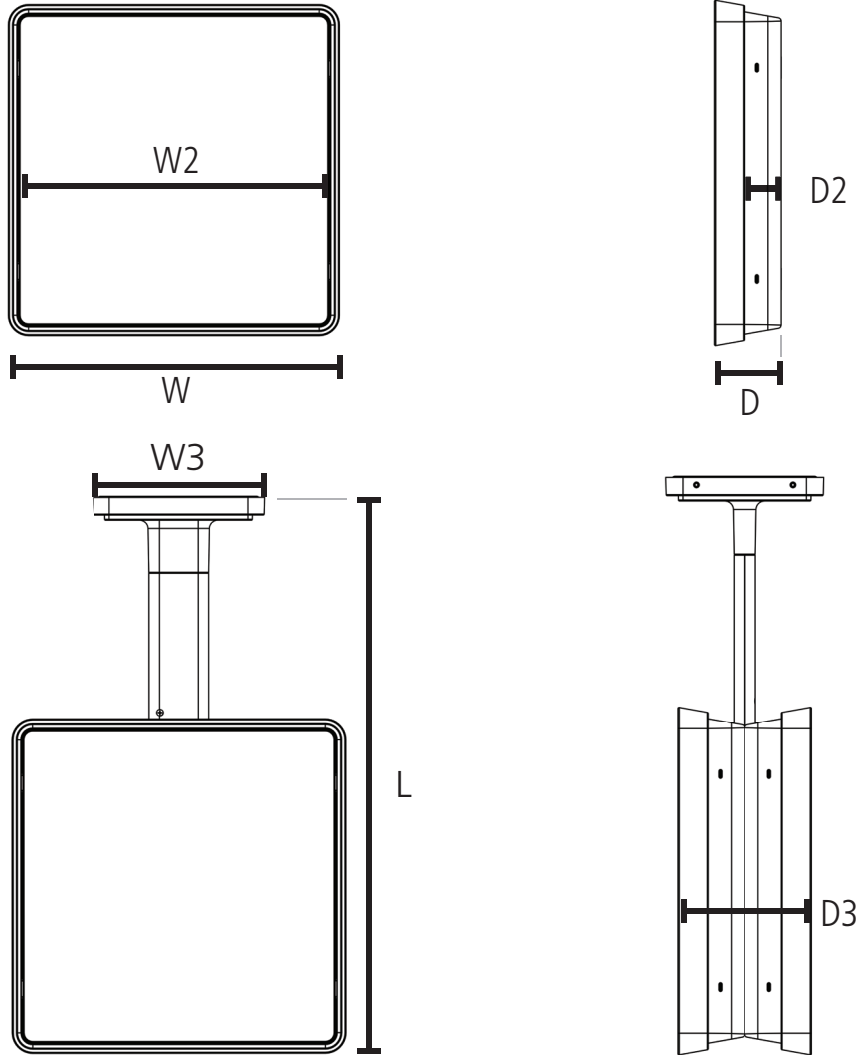

	9" Square	12" Square
Clock Size:	W = 9.79" (24.9cm)	W = 12.76" (32.4cm)
	W2 = 8.97" (22.8cm)	W2 = 11.94" (30.3cm)
	D = 2.44" (6.2cm)	D = 2.44" (6.2cm)
	D2 = 1.34" (3.4cm)	D2 = 1.34" (3.4cm)
Shipping Weight:	3.0lbs (1.81kg)	4.0lbs (1.81kg)
Double/Dual Mount Dimensions:	W3 = 6.56" (16.7cm)	W3 = 6.56" (16.7cm)
	D3 = 4.93" (12.5cm)	D3 = 4.93" (12.5cm)
Adjustable Pole Height for standard pole*:	L3 = 18.32" (46.5cm)	L = 21.12" (53.6cm)
		L = 19.35" (49.1cm)
Shortened Pole Height:	L = 12.38" (31.4cm)	L = 15.50" (39.3cm)

\*Standard pole refers to part number SAB-1GD-00S-0

\*\*Shortened pole (ceiling mount only) refers to part number SAB-1GD-01S-0

# SAI Series Quartz Independent Square Clock (V5.8)

## Hand & Dial Options



Standard Hands

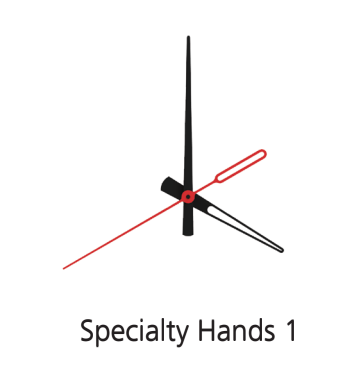

Specialty Hands 1

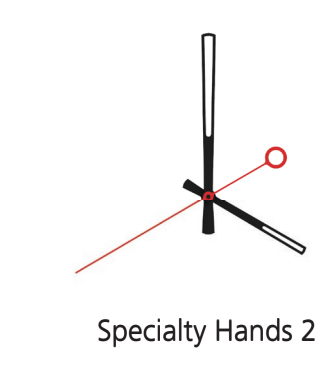

Specialty Hands 2

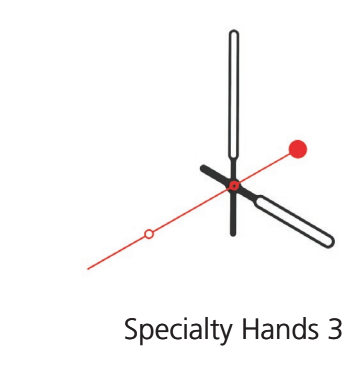

Specialty Hands 3

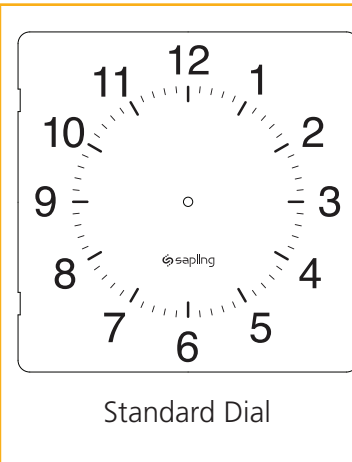

Standard Dial

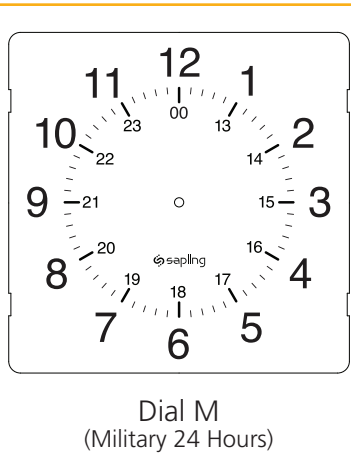

Dial M  
(Military 24 Hours)

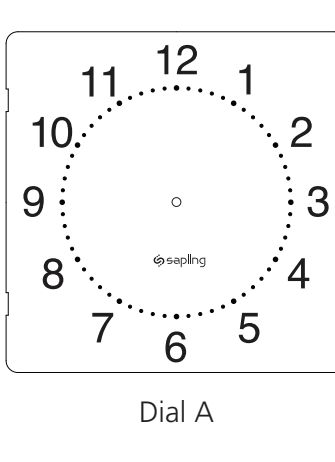

Dial A

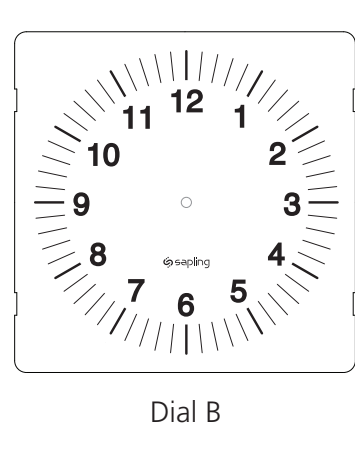

Dial B

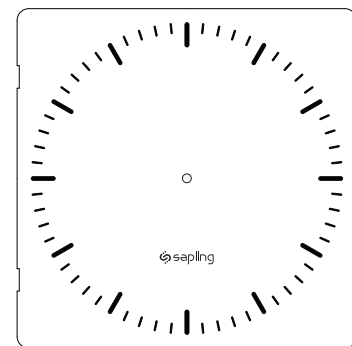

Dial C

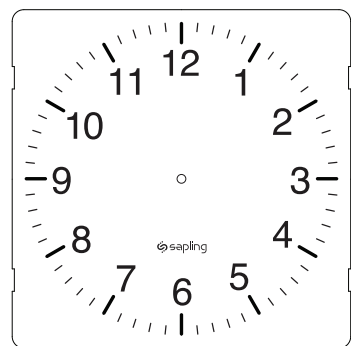

Dial D

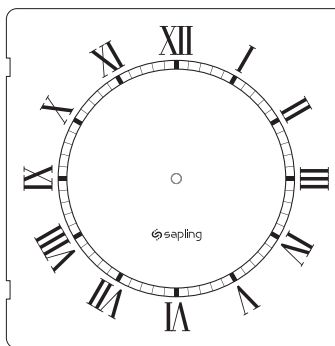

Dial E

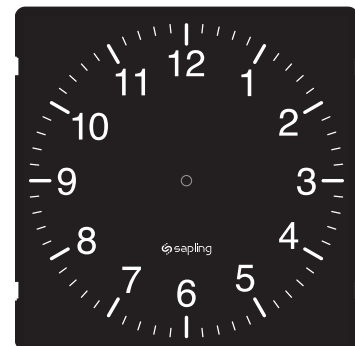

Dial F

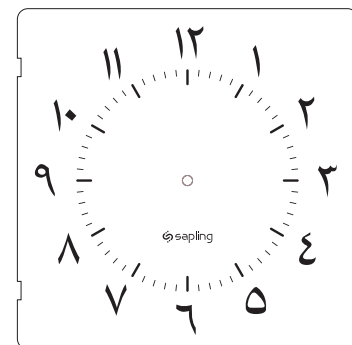

Dial G

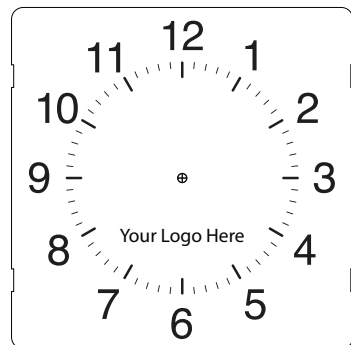

Dial Z

Specialty Hands 1-3 & Specialty Dials A-Z are offered at an additional cost.

For more information please contact your Sapling Representative.